

Look for it on  
Blu-ray™, DVD & Digital HD



Hey kids,  
make sure to ask an  
adult for help!



## HICCUP PAPER TOY

### ASSEMBLY INSTRUCTIONS

**1** Score all the pieces, using a ruler as a guide and running the backside of a butter knife firmly along all dotted lines.



**2** Using scissors or a craft knife and cutting mat, cut out all pieces along solid lines.



### GETTING STARTED

#### Materials:

- Metal-edged ruler
- Butter knife
- Scissors or craft knife
- Cutting mat (optional)
- Multipurpose glue

**3** Fold all pieces along score lines, using the folding key below as a reference.

Mountain Fold



Valley Fold



### ASSEMBLE HICCUP

**1** Body: Poke holes in the X slits. Insert a pencil in each slit to make the holes wider.

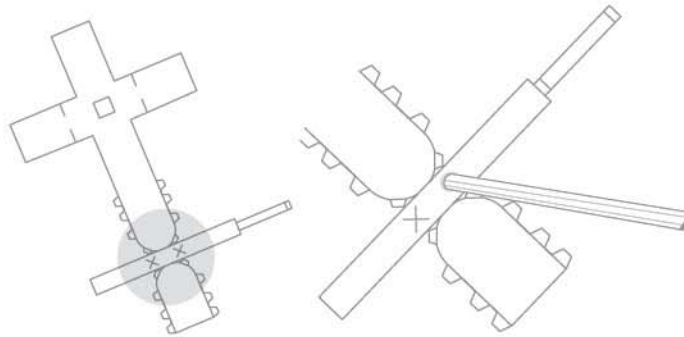

**2** Legs: Using a pencil loosely roll leg pieces to form a cylinder. Add glue and hold until dry. Remove pencil.

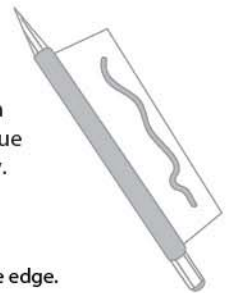

**TIP:**  
Add glue just before edge.

**3** Body: Fold side panels up and glue to A tabs, starting with left side then right side. Let dry. Fold top panel across opening and glue B tab to other side to close. Fold down top of body and glue to bottom of body. Let dry.

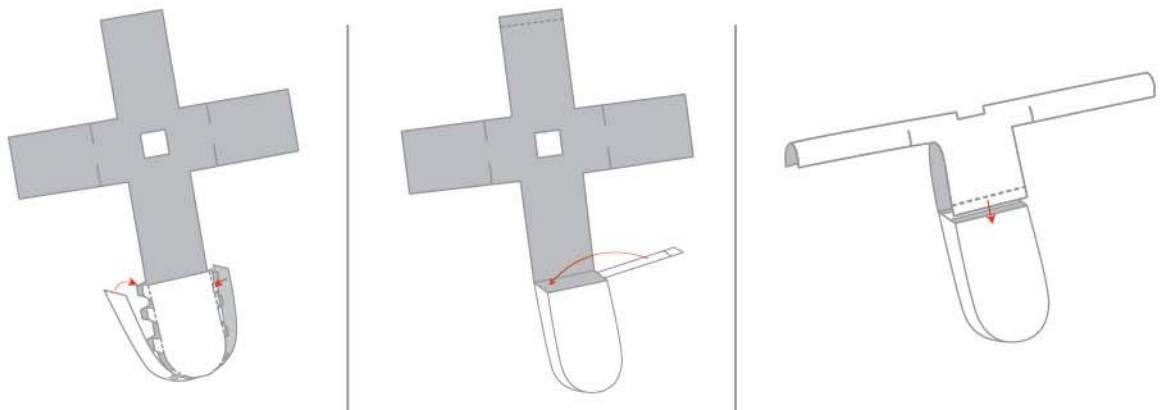

## ASSEMBLY INSTRUCTIONS CONTINUED

4

Legs: Insert legs into body through leg holes. Glue to secure.

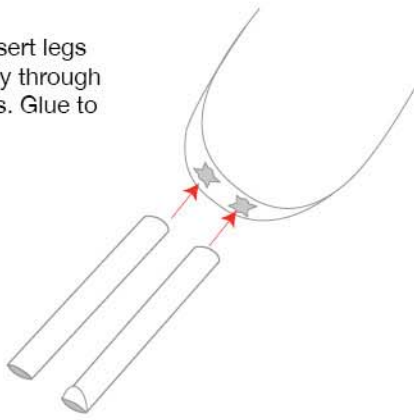

5

Wings: Fold in half along dotted line and glue. Cut away excess paper to create wing shape. Turn body wrap so art faces you. Glue wing tabs into leather body wrap slits.

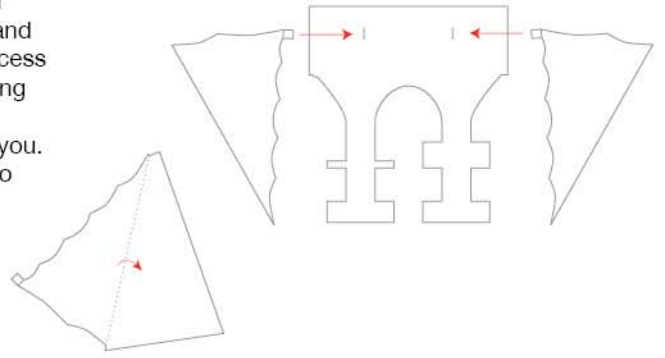

6

Body Wrap: Keeping the buckle wraps in the front, wrap body wrap with wings attached around body. Glue front of wrap and leg straps to secure.

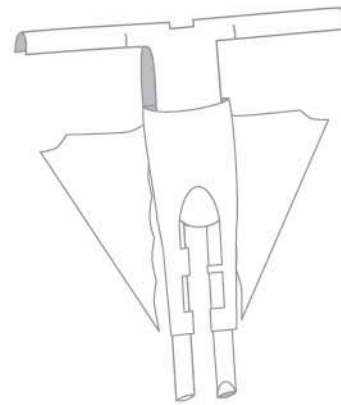
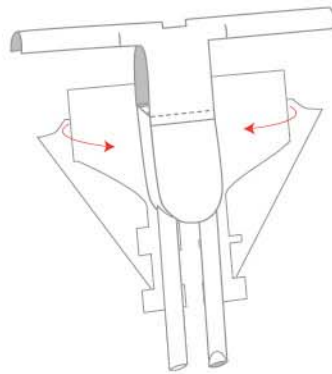

7

Boot: Glue A tabs to side panel. Close back of boot by folding side panel over B tabs. Glue to secure.

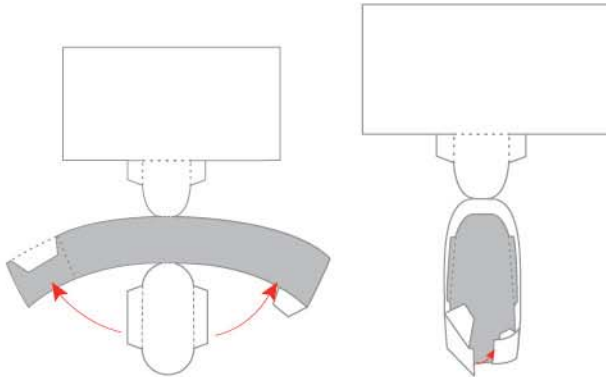

8

Boot: Turn boot to face you. Glue C tabs to inside of side panel.

Bend top of boot at score line towards the front of the boot.

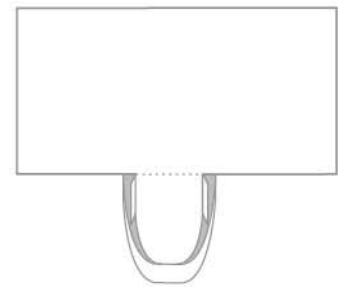

9

Boots: Turn boot away from you. Curl and glue top of boot together, creating a cylinder.

When boot is dry, place onto right leg end and glue to secure.

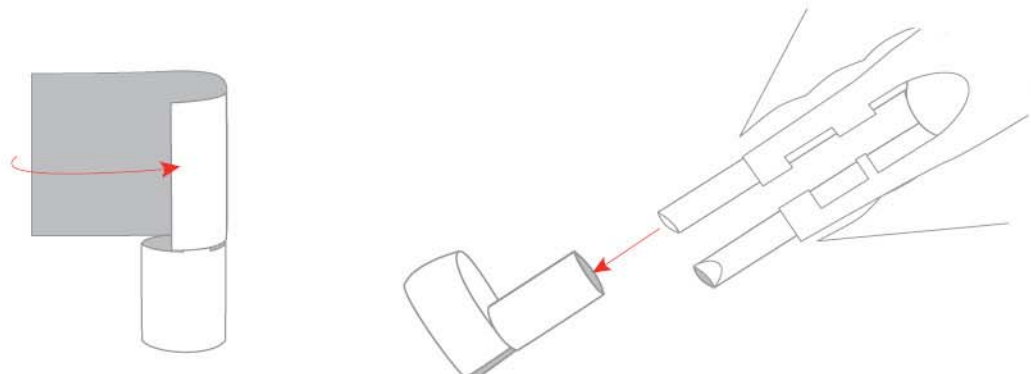

## ASSEMBLY INSTRUCTIONS CONTINUED

10

Shoulder pads:  
Glue shoulder pads to underside of vest so that tabs line up with edge of vest. Let dry.

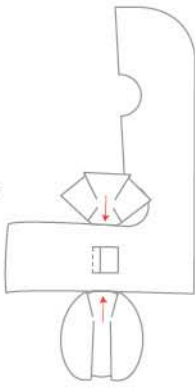

11

Vest: Glue front of vest to front of body, making sure to line up vest and head hole. Glue back of vest to back of body. Wrap left side of vest around back of body and back over the front. Glue to secure and let dry.

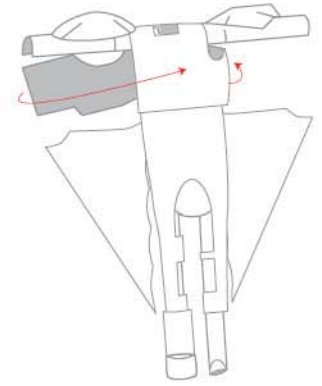
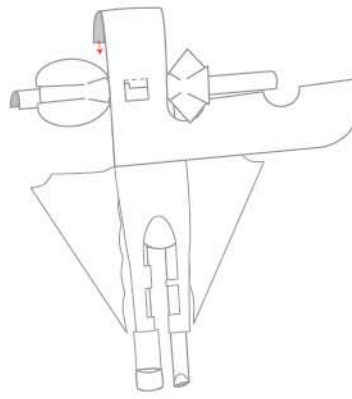

12

Arms: Fold in half along dotted line and glue. Cut away excess paper to create arm shape. Attach arms to underside of arm flaps and glue to secure. Fold arm flaps down over arms and glue to secure. Glue shoulder pad flaps together to cover shoulders.

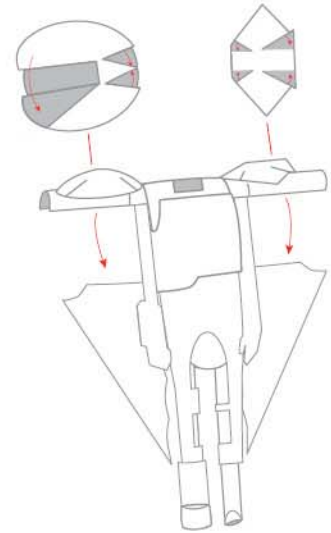
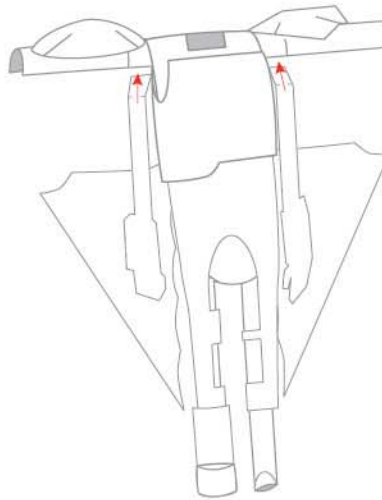
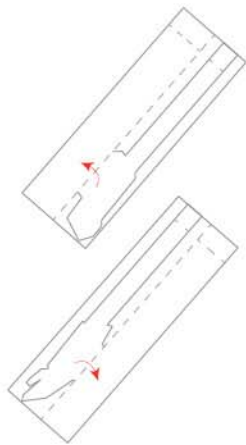

13

Head: Starting with the back of the head, glue A tabs, let dry. Repeat on right side with B tabs, let dry. Carefully place head into neck hole.

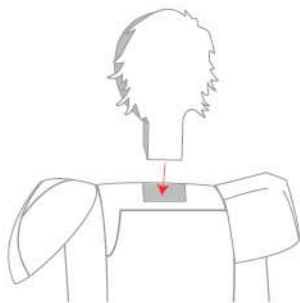
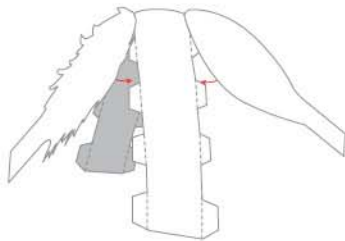

14

Fire Sword: Fold sword in half, glue together and let dry. Cut away excess paper to create sword shape.

Cut along solid lines and glue Axe to inside of left hand.

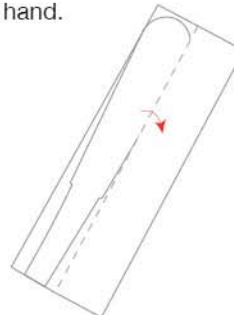

You're Done!

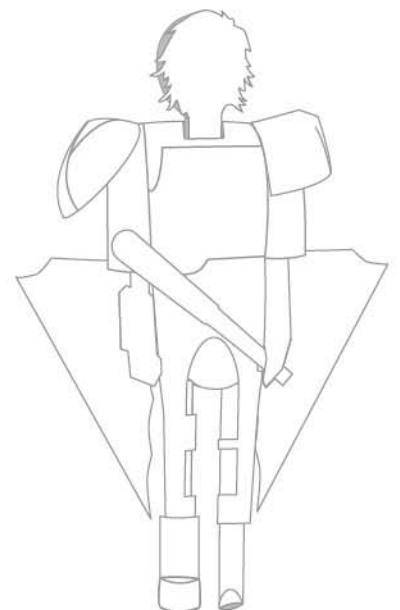

BODY

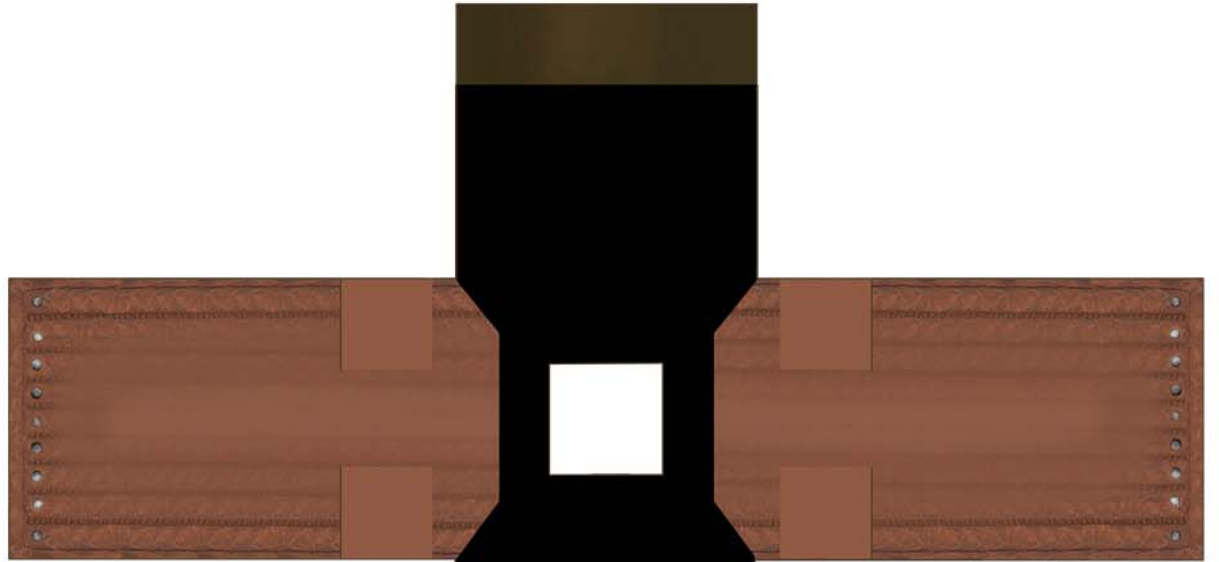

SHOULDER PAD RIGHT

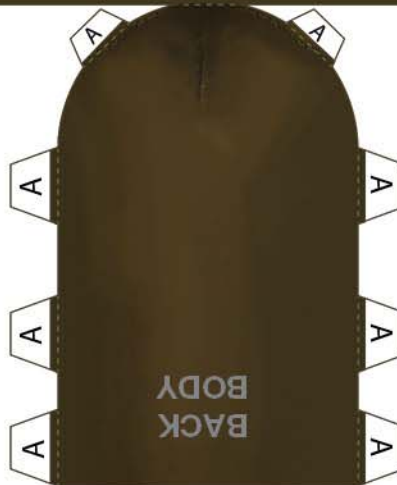
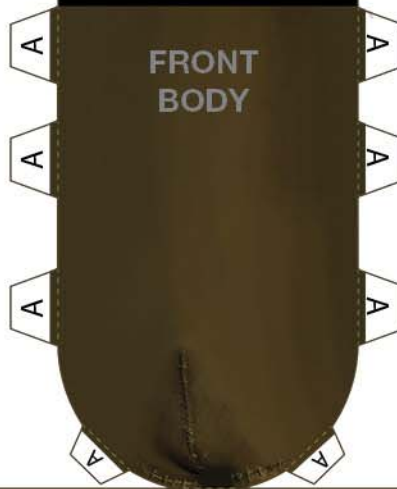

**RIGHT WING**



**RIGHT ARM**



**LEFT WING**

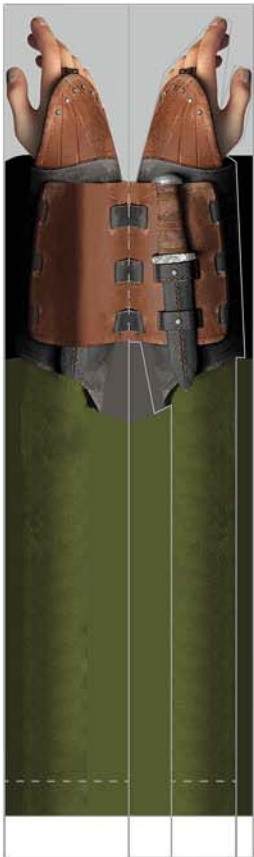

**LEFT ARM**

**FIRE SWORD**

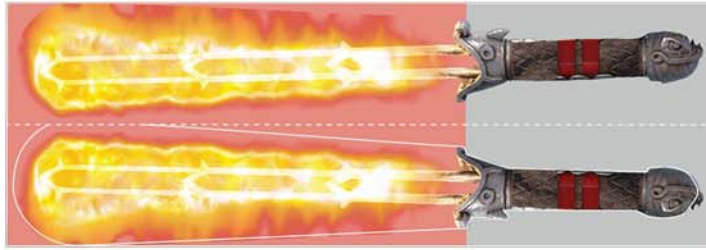

**RIGHT LEG**



**LEFT LEG**



**BODY WRAP**



**ARMOR**

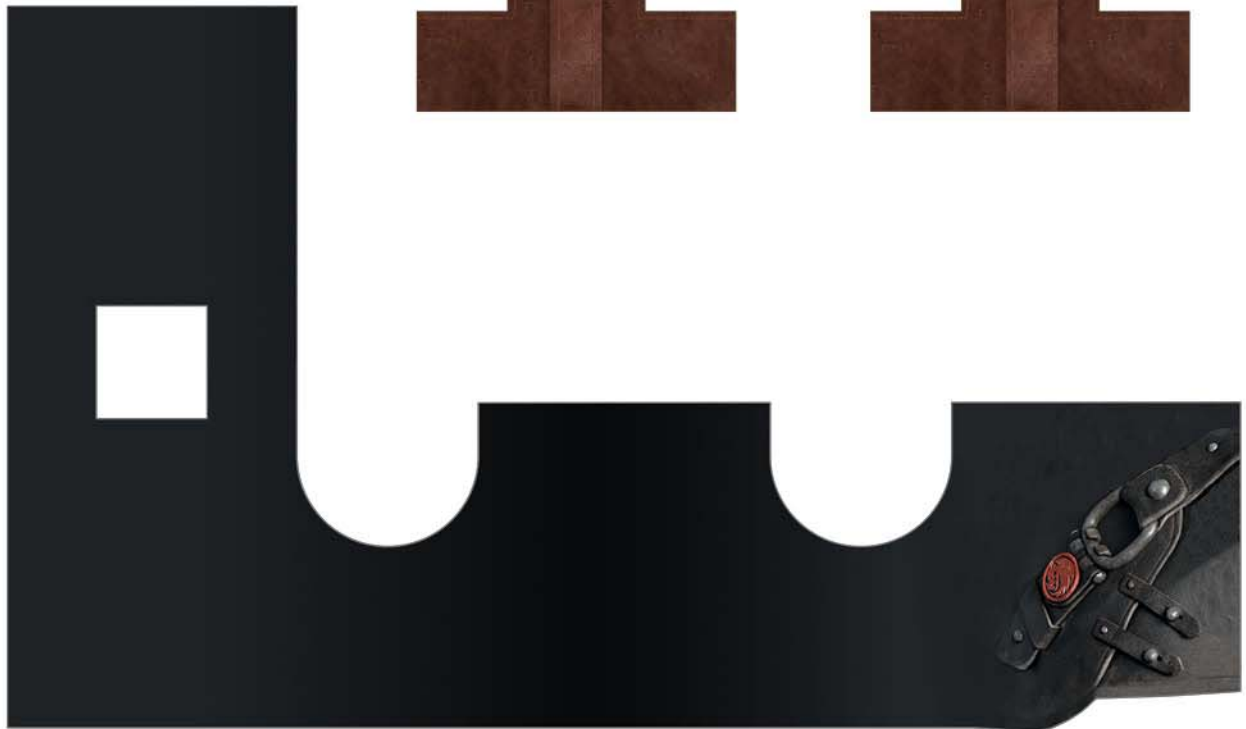

HEAD



SHOULDER PAD LEFT

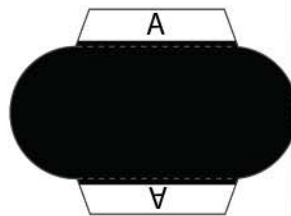
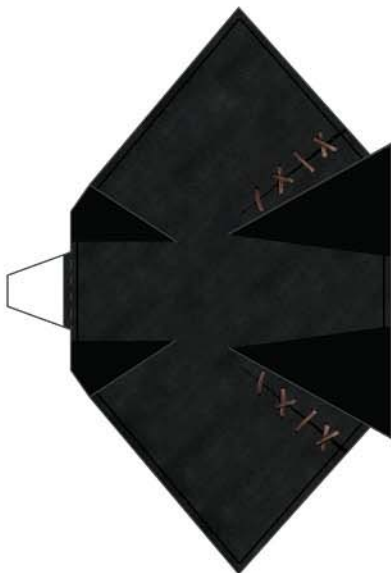

BOOT

